

Przenośniki

Piotr Malenta 2010

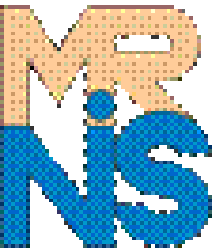

Centra przeładowcze

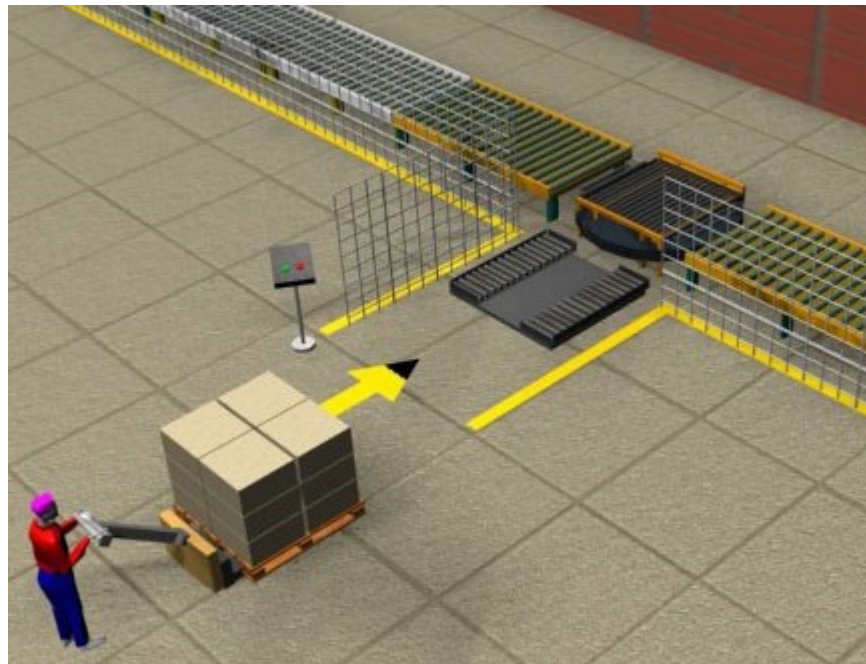

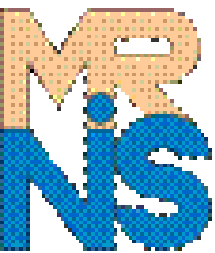

Centra przeładowcze



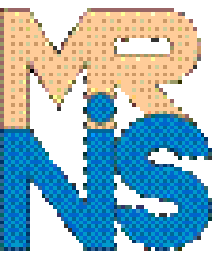

Centra przeładowcze



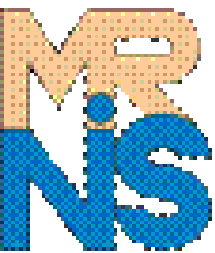

Centra przeładowcze



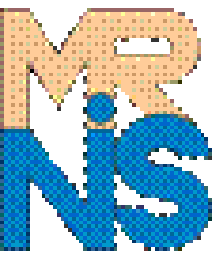

Przenośniki unoszone



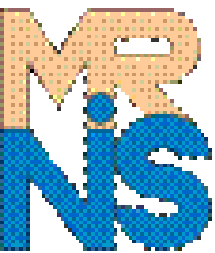

Przenośniki unoszone



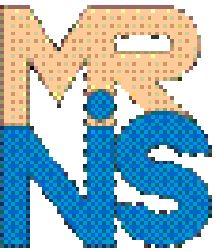

Przenośniki unoszone



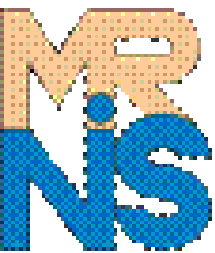

Przenośniki unoszone

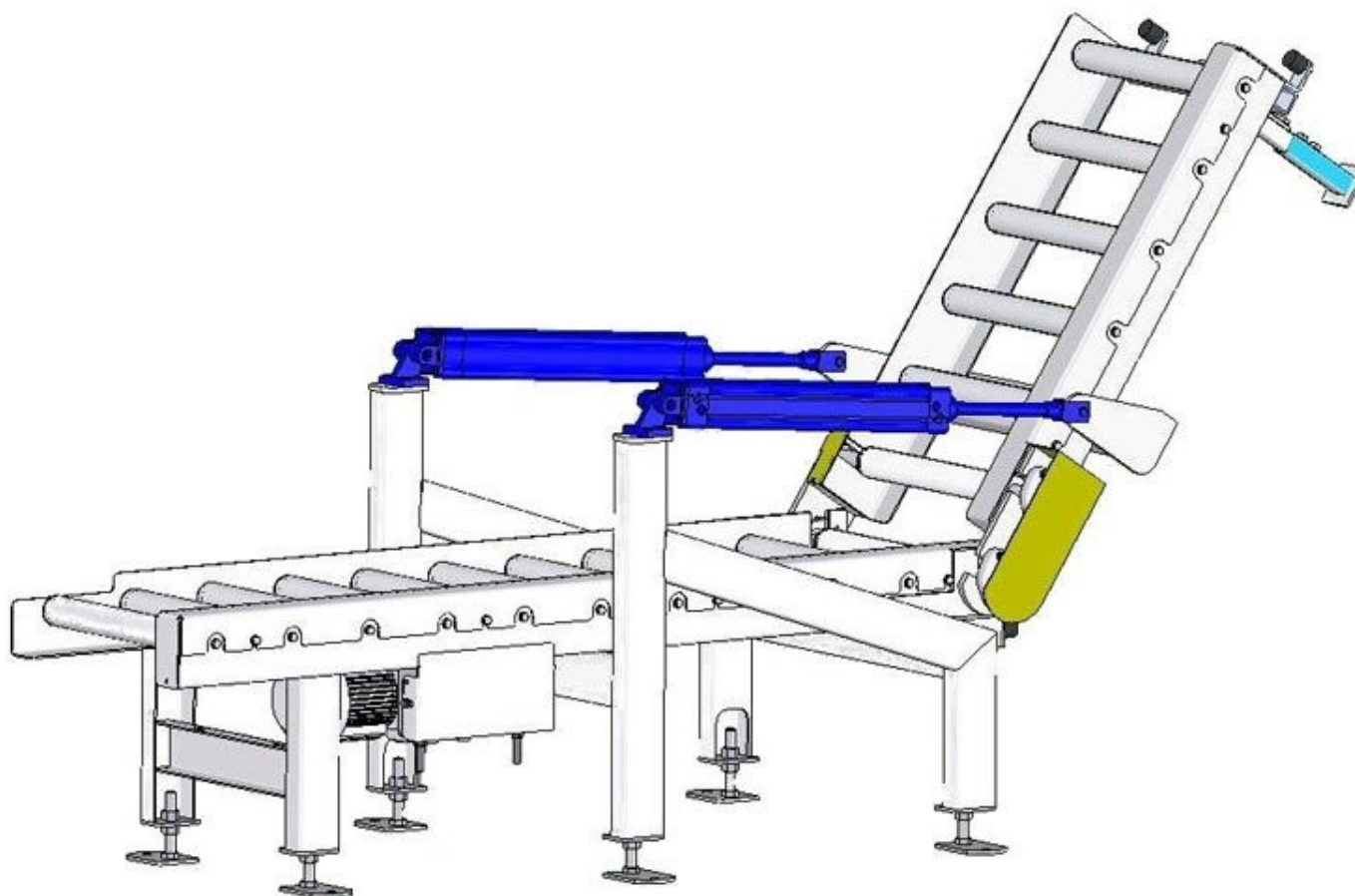

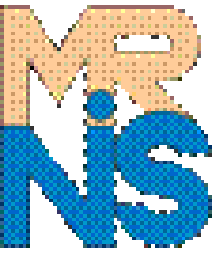

Przenośniki unoszone



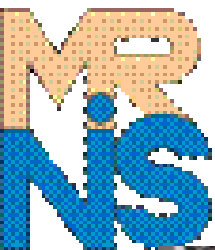

Magazyny blach



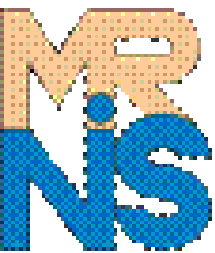

Magazyny blach



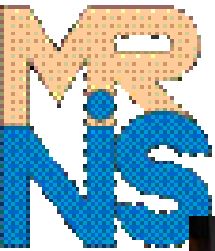

Magazyny blach



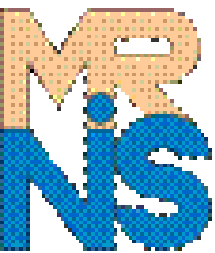

Podwójny magazyn składający się z dwóch regałów i ruchomej windy.



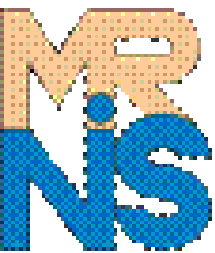

Magazyn z większą ilością regałów, wyposażony w windę poruszającą się pomiędzy regałami.



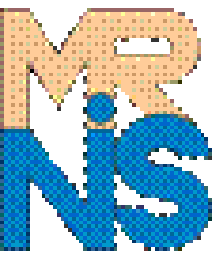

Magazyn surowców, półwyrobów współpracujący z obrabiarką.

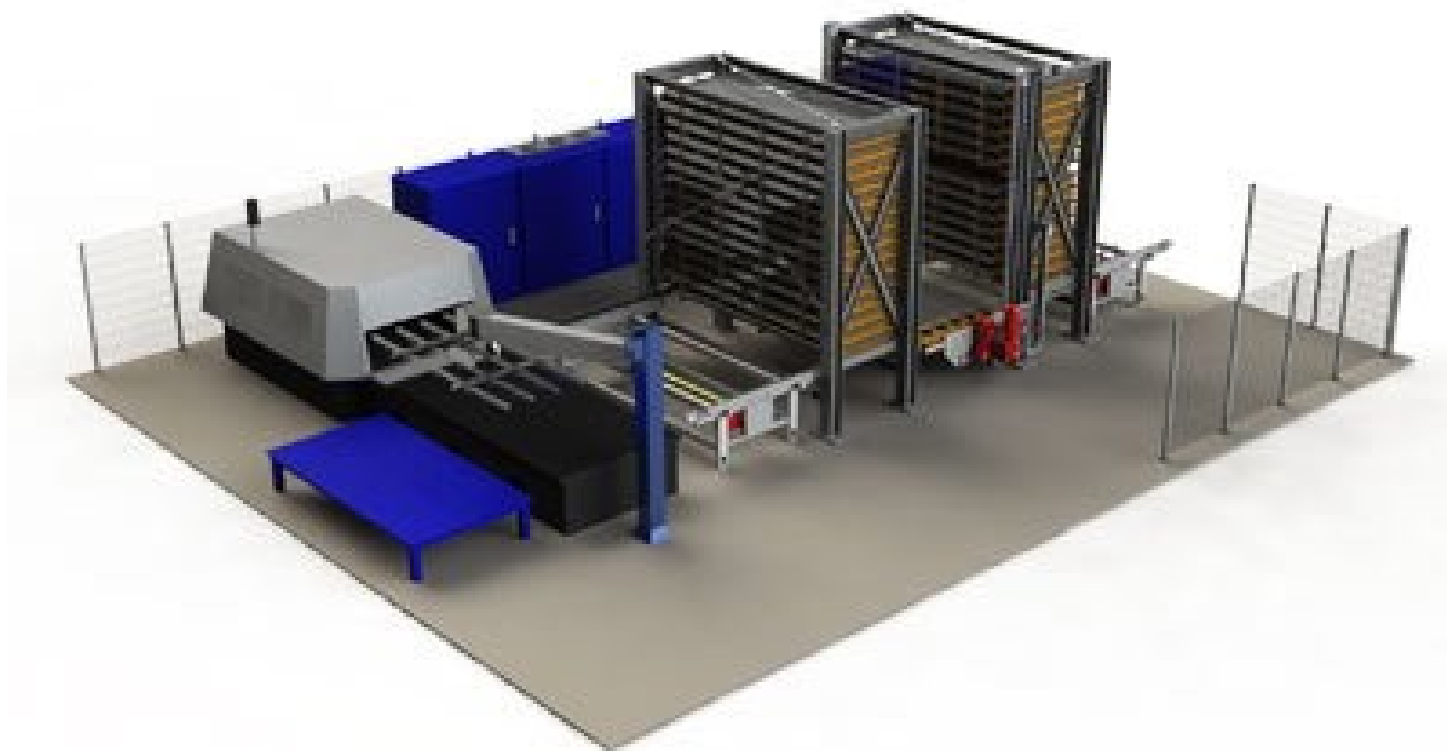

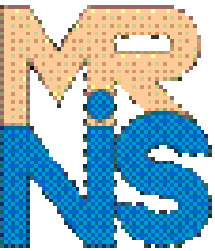

Pakowanie wyrobów w woreczki



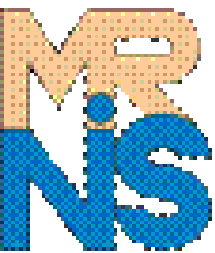

Dystrybutor napojów



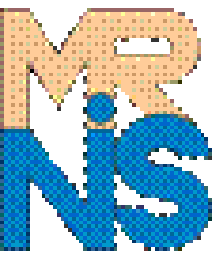

Przenośnik paletowy



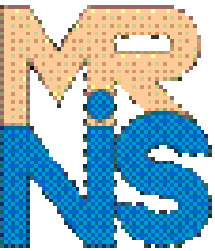

Przenośnik paletowy - rozdzielnia



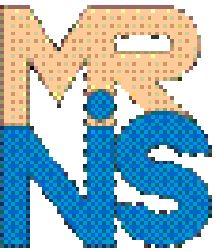

Przenośnik - AWARIA



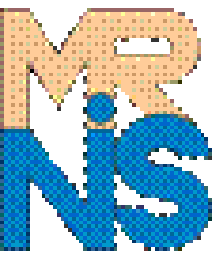

Zautomatyzowany parking (Unitronics)

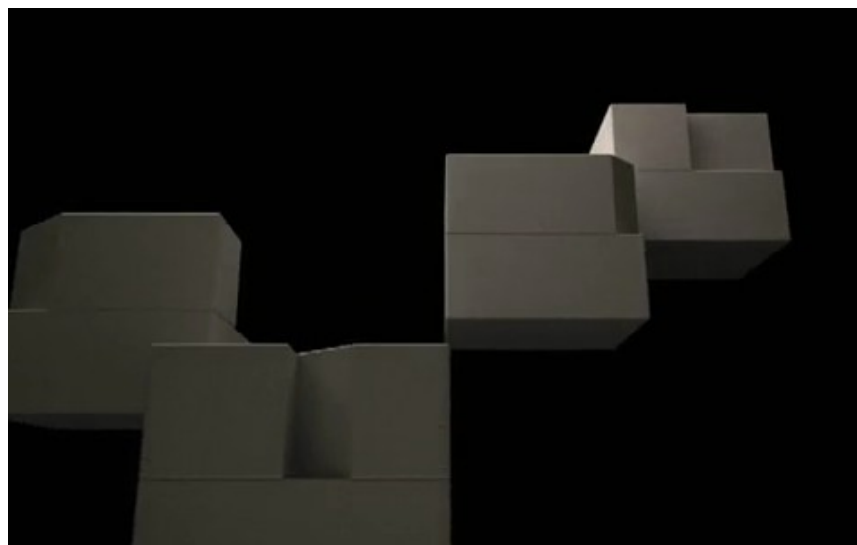

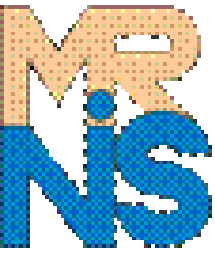

Automatyczny parking (Portugalia)

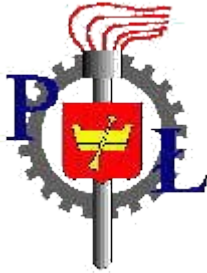

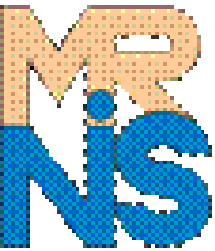

Samoobsługowy magazyn kontenerowy



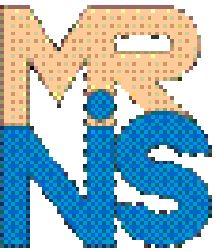

Metoda parkowania ...



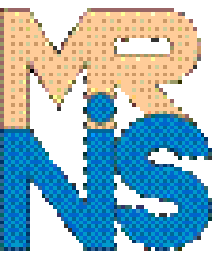

Przenośniki

Piotr Malenta 2010